

## 2862

18 WATT, 39 WATT, 40 WATT AND 50 WATT LOW PROFILE INTEGRAL MODULES

- Constructed of Satin Anodized Formed Aluminum
- High Performance Compact Fluorescent Lamp Options:
  - 18 watt (2G11) Rapid Start
  - 39 watt (2G11)
  - 40 watt (2G11)
  - 50 watt (2G11)
 (refer to page 8-33)
- Voltage Options:
  - 120 volt
  - 277 volt
- Integral Ballast Options (refer to page III)
  - High Power Factor
  - Electronic
  - Dimming (39, 40 & 50 watt only)
 Emergency Ballasts are available. Please consult factory.
- UL and CUL Listed Damp Location



18 WATT INTEGRAL



39 WATT INTEGRAL



40/50 WATT INTEGRAL

### Fixture Dimensions

Lamp	A
18 watt	24"
39 watt	30"
40 watt	36"
50 watt	36"

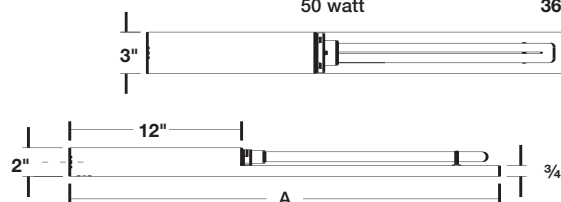

Allow 4" for lamp overhang and removal

## Ordering Format for 2862 Low Profile Integral Module

Choose one from each category

SERIES	BALLAST MOUNT	LAMP	VOLTAGE	BALLAST
2862 module	I integral	18 18 watt compact fluorescent (rapid start)	1 120 volt	H high power factor
		39 39 watt compact fluorescent	2 277 volt	E electronic
		40 40 watt compact fluorescent		D dimming (39, 40 & 50 watt only)
		50 50 watt compact fluorescent		



These products protected by one or more of the following U.S. Patent Numbers 5,448,460, 5,221,139 & 5,452,187. Other patents pending. Modifications and custom configurations are available. Please contact our Sales Department.

**BELFER** LIGHTING FOR ARCHITECTURE

TEL: (732) 493-2666 . FAX: (732) 493-2941 . www.belfer.com

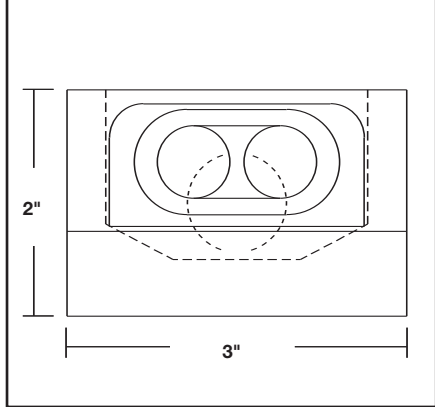

# 2862

18 WATT, 39 WATT, 40 WATT & 50 WATT LOW PROFILE REMOTE MODULES

- Constructed of Satin Anodized Formed Aluminum
- High Performance Compact Fluorescent Lamp Options:
  - 18 watt (2G11) Rapid Start
  - 39 watt (2G11)
  - 40 watt (2G11)
  - 50 watt (2G11)
 (refer to page 8-33)
- Voltage Options:
  - 120 volt
  - 277 volt
- Remote Ballast Options (refer to page III)
  - High Power Factor
  - Electronic
  - Dimming (39, 40 & 50 watt only)
 Emergency Ballasts are available. Please consult factory.
- Remote Ballast Box Constructed of White Formed Aluminum (2" x 3" x 12") (refer to page III)
- UL and CUL Listed Damp Location



18 WATT REMOTE



39 WATT REMOTE



40/50 WATT REMOTE

**Fixture Dimensions**

Lamp	A
18 watt	14"
39 watt	20"
40 watt	26"
50 watt	26"

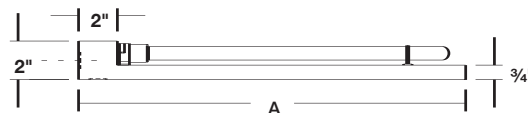
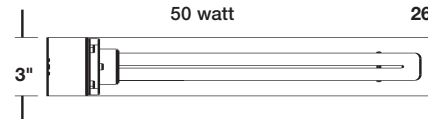

## Ordering Format for 2862 Low Profile Remote Module

Choose one from each category

SERIES	BALLAST MOUNT	LAMP	VOLTAGE	BALLAST
2862 module	R remote	18 18 watt compact fluorescent (rapid start)	1 120 volt	H high power factor
		39 39 watt compact fluorescent	2 277 volt	E electronic
		40 40 watt compact fluorescent		D dimming (39, 40 & 50 watt only)
		50 50 watt compact fluorescent		



These products protected by one or more of the following U.S. Patent Numbers 5,448,460, 5,221,139 & 5,452,187. Other patents pending. Modifications and custom configurations are available. Please contact our Sales Department.

**BELFER** LIGHTING FOR ARCHITECTURE

Product Code	U/M	Description
<b>2801 SERIES</b>		
<input type="checkbox"/> CF9/35K	ea	9 watt Twin G23 base Compact Fluorescent 3500°K
<input type="checkbox"/> CF13/35K	ea	13 watt Twin GX23 base Compact Fluorescent 3500°K
<b>2850 SERIES</b>		
<input type="checkbox"/> CF18/35K/RS	ea	18 watt Twin 2G11 base Compact Fluorescent 3500°K Rapid Start
<input type="checkbox"/> CF39/35K	ea	39 watt Twin 2G11 base Compact Fluorescent 3500°K
<input type="checkbox"/> CF40/35K	ea	40 watt Twin 2G11 base Compact Fluorescent 3500°K
<input type="checkbox"/> CF50/35K	ea	50 watt Twin 2G11 base Compact Fluorescent 3500°K
<b>2855 SERIES</b>		
<input type="checkbox"/> CF9/35K	ea	9 watt Twin G23 base Compact Fluorescent 3500°K
<input type="checkbox"/> CF13/35K	ea	13 watt Twin GX23 base Compact Fluorescent 3500°K
<input type="checkbox"/> CF18/35K/RS	ea	18 watt Twin 2G11 base Compact Fluorescent 3500°K Rapid Start
<input type="checkbox"/> CF39/35K	ea	39 watt Twin 2G11 base Compact Fluorescent 3500°K
<input type="checkbox"/> CF40/35K	ea	40 watt Twin 2G11 base Compact Fluorescent 3500°K
<input type="checkbox"/> CF50/35K	ea	50 watt Twin 2G11 base Compact Fluorescent 3500°K
<b>2862 SERIES</b>		
<input type="checkbox"/> CF9/35K	ea	9 watt Twin G23 base Compact Fluorescent 3500°K
<input type="checkbox"/> CF13/35K	ea	13 watt Twin GX23 base Compact Fluorescent 3500°K
<input type="checkbox"/> CF18/35K/RS	ea	18 watt Twin 2G11 base Compact Fluorescent 3500°K Rapid Start
<input type="checkbox"/> CF39/35K	ea	39 watt Twin 2G11 base Compact Fluorescent 3500°K
<input type="checkbox"/> CF40/35K	ea	40 watt Twin 2G11 base Compact Fluorescent 3500°K
<input type="checkbox"/> CF50/35K	ea	50 watt Twin 2G11 base Compact Fluorescent 3500°K
<b>2880 SERIES</b>		
<input type="checkbox"/> CF18Q/35K/4	ea	18 watt Quad G24q-2 base Compact Fluorescent 3500°K
<input type="checkbox"/> CF26Q/35K/4	ea	26 watt Quad G24q-3 base Compact Fluorescent 3500°K
<input type="checkbox"/> CF32H/35K/4	ea	32 watt Triple GX24q-3 base Compact Fluorescent 3500°K
<input type="checkbox"/> CF42H/35K/4	ea	42 watt Triple GX24q-4 base Compact Fluorescent 3500°K



2850 and 2855 installations where the lamp is in the down position may require an auxiliary lamp clip that snaps over standard lamp clip. Please order P-2013-01-00 (one required per lamp)

# Reflector Fabrication Sheet

YOUR REFLECTOR DESIGN CAN BE INCORPORATED INTO ANY BELFER COMPACT FLUORESCENT OR LINEAR FLUORESCENT FIXTURE. SYMMETRICAL OR ASYMMETRICAL, STRAIGHT OR SAW TOOTHED, WHITE OR CHROME... THE POSSIBILITIES ARE LIMITLESS. CHOOSE FROM A STANDARD REFLECTOR DESIGN BELOW OR DRAW YOUR OWN TO DISCUSS THE POSSIBILITIES. ALL REFLECTORS ARE AVAILABLE IN 4' LENGTHS AND ARE FIELD TRIMMABLE.

**SELECT FIXTURE NUMBER:**

- 2801 COMPACT FLUORESCENT
- 2850 COMPACT FLUORESCENT
- 2855 COMPACT FLUORESCENT
- 2880 COMPACT FLUORESCENT

**SELECT REFLECTOR DESIGN:**

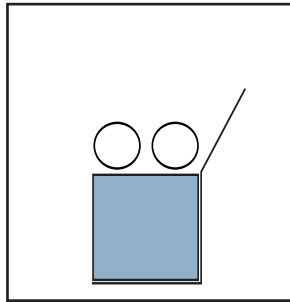

REFLECTOR A

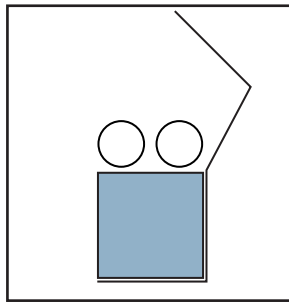

REFLECTOR B

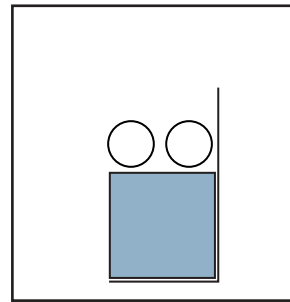

REFLECTOR C

- CUSTOM REFLECTOR    Job Plans or Drawings are Required

