

**2801 FX2 9/13 WATT  
LAMPS FACING UP**

## 2801 NX2™ & FX2™

9 WATT AND 13 WATT SEAMLESS STRAIGHT AND FIELD CURVABLE SYSTEM

- Linkable Seamless Straight and Field Curvable Lengths
- Constructed of Formed Satin Anodized Aluminum
- 9 watt (G23) Compact Fluorescent Lamp  
*(refer to page 8-33)*
- 13 watt (GX23) Compact Fluorescent Lamp  
*(refer to page 8-33)*
- Voltage Options:
  - 120 volt
  - 277 volt
- High Power Factor Ballasts *(refer to page III)*
- 8" On Center Spacing
- Lengths Through Wired for Easy Installation
- Exterior Mounting Clips for Quick, Easy Anchoring
- Custom Reflectors can be manufactured to your specifications.  
*(refer to page 8-34)*
- UL and CUL Listed Damp Location

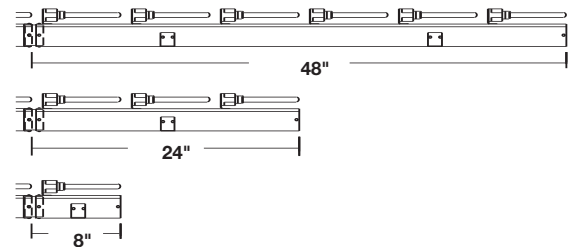

### Ordering Format for 2801 NX2 & FX2

*Choose one from each category*

SERIES	LAMP CONFIGURATION	LAMP	VOLTAGE	BALLAST	LENGTH
<b>2801</b> linear fixture	<b>NX2</b> seamless straight lamp up or down	<b>9</b> 9 watt compact fluorescent	<b>1</b> 120 volt	<b>H</b> high power factor	<b>48</b> 48" length <i>(6 lamps)</i>
	<b>FX2</b> field curvable lamp up or down	<b>13</b> 13 watt compact fluorescent	<b>2</b> 277 volt		<b>24</b> 24" length <i>(3 lamps)</i>
					<b>8</b> 8" length <i>(1 lamp)</i>



*These products protected by one or more of the following U.S. Patent Numbers 5,448,460, 5,221,139 & 5,452,187. Other patents pending. Modifications and custom configurations are available. Please contact our Sales Department.*

**BELFER** LIGHTING FOR ARCHITECTURE

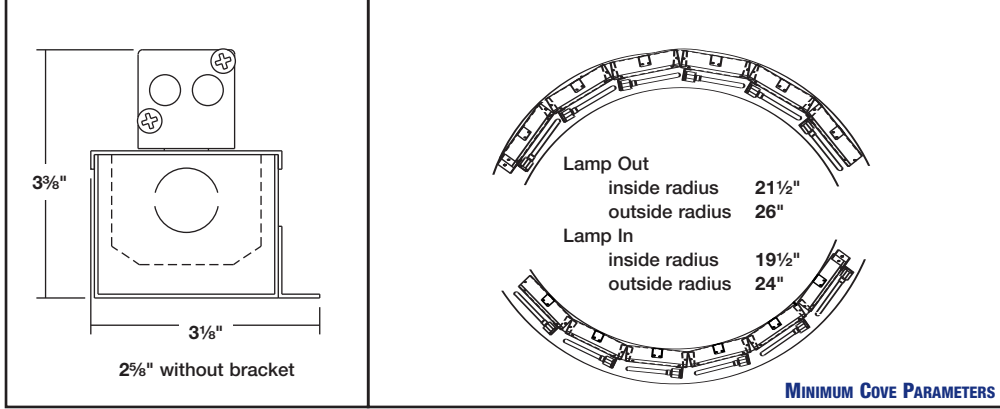

## 2801 NX2S™ & FX2S™

9 WATT AND 13 WATT SEAMLESS STRAIGHT AND FIELD CURVABLE SYSTEM

- Linkable Seamless Straight and Field Curvable Lengths
- Constructed of Formed Satin Anodized Aluminum
- 9 watt (G23) Compact Fluorescent Lamp  
*(refer to page 8-33)*
- 13 watt (GX23) Compact Fluorescent Lamp  
*(refer to page 8-33)*
- Voltage Options:
  - 120 volt
  - 277 volt
- High Power Factor Ballasts *(refer to page III)*
- 8" On Center Spacing
- Lengths Through Wired for Easy Installation
- Exterior Mounting Clips for Quick, Easy Anchoring
- Custom Reflectors can be manufactured to your specifications.  
*(refer to page 8-34)*
- UL and CUL Listed Damp Location

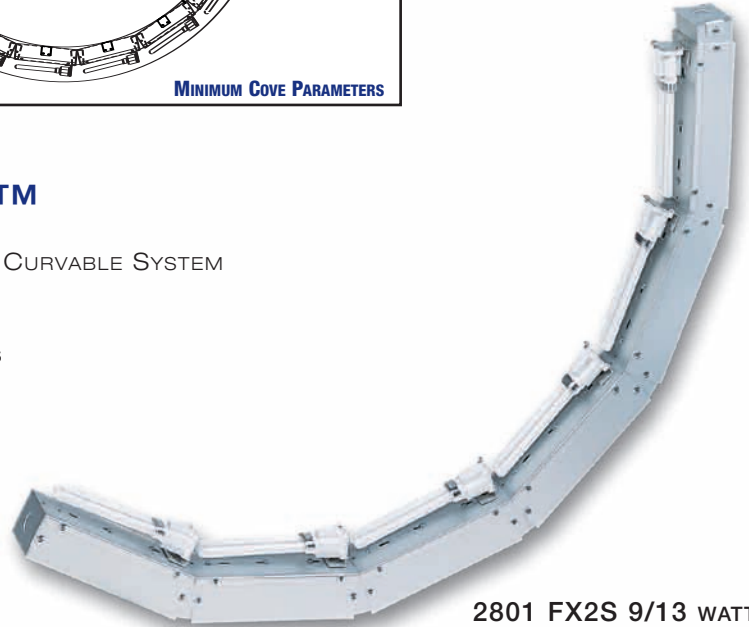

2801 FX2S 9/13 WATT  
Lamps facing in

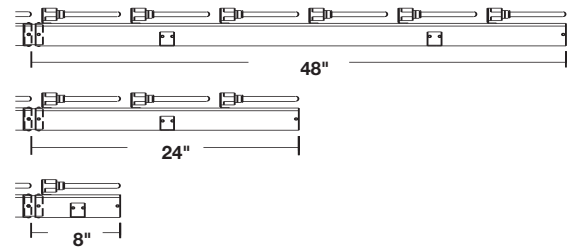

### Ordering Format for 2801 NX2S & FX2S

*Choose one from each category*

SERIES	LAMP CONFIGURATION	LAMP	VOLTAGE	BALLAST	LENGTH
2801 linear fixture	NX2S seamless straight lamp in or out (13 watt is lamp out only)	9 9 watt compact fluorescent	1 120 volt	H high power factor	48 48" length <i>(6 lamps)</i>
		13 13 watt compact fluorescent	2 277 volt		24 24" length <i>(3 lamps)</i>
	FX2S field curvable lamp in or out				8 8" length <i>(1 lamp)</i>



*These products protected by one or more of the following U.S. Patent Numbers 5,448,460, 5,221,139 & 5,452,187. Other patents pending. Modifications and custom configurations are available. Please contact our Sales Department.*

Product Code	U/M	Description
<b>2801 SERIES</b>		
<input type="checkbox"/> CF9/35K	ea	9 watt Twin G23 base Compact Fluorescent 3500°K
<input type="checkbox"/> CF13/35K	ea	13 watt Twin GX23 base Compact Fluorescent 3500°K
<b>2850 SERIES</b>		
<input type="checkbox"/> CF18/35K/RS	ea	18 watt Twin 2G11 base Compact Fluorescent 3500°K Rapid Start
<input type="checkbox"/> CF39/35K	ea	39 watt Twin 2G11 base Compact Fluorescent 3500°K
<input type="checkbox"/> CF40/35K	ea	40 watt Twin 2G11 base Compact Fluorescent 3500°K
<input type="checkbox"/> CF50/35K	ea	50 watt Twin 2G11 base Compact Fluorescent 3500°K
<b>2855 SERIES</b>		
<input type="checkbox"/> CF9/35K	ea	9 watt Twin G23 base Compact Fluorescent 3500°K
<input type="checkbox"/> CF13/35K	ea	13 watt Twin GX23 base Compact Fluorescent 3500°K
<input type="checkbox"/> CF18/35K/RS	ea	18 watt Twin 2G11 base Compact Fluorescent 3500°K Rapid Start
<input type="checkbox"/> CF39/35K	ea	39 watt Twin 2G11 base Compact Fluorescent 3500°K
<input type="checkbox"/> CF40/35K	ea	40 watt Twin 2G11 base Compact Fluorescent 3500°K
<input type="checkbox"/> CF50/35K	ea	50 watt Twin 2G11 base Compact Fluorescent 3500°K
<b>2862 SERIES</b>		
<input type="checkbox"/> CF9/35K	ea	9 watt Twin G23 base Compact Fluorescent 3500°K
<input type="checkbox"/> CF13/35K	ea	13 watt Twin GX23 base Compact Fluorescent 3500°K
<input type="checkbox"/> CF18/35K/RS	ea	18 watt Twin 2G11 base Compact Fluorescent 3500°K Rapid Start
<input type="checkbox"/> CF39/35K	ea	39 watt Twin 2G11 base Compact Fluorescent 3500°K
<input type="checkbox"/> CF40/35K	ea	40 watt Twin 2G11 base Compact Fluorescent 3500°K
<input type="checkbox"/> CF50/35K	ea	50 watt Twin 2G11 base Compact Fluorescent 3500°K
<b>2880 SERIES</b>		
<input type="checkbox"/> CF18Q/35K/4	ea	18 watt Quad G24q-2 base Compact Fluorescent 3500°K
<input type="checkbox"/> CF26Q/35K/4	ea	26 watt Quad G24q-3 base Compact Fluorescent 3500°K
<input type="checkbox"/> CF32H/35K/4	ea	32 watt Triple GX24q-3 base Compact Fluorescent 3500°K
<input type="checkbox"/> CF42H/35K/4	ea	42 watt Triple GX24q-4 base Compact Fluorescent 3500°K



2850 and 2855 installations where the lamp is in the down position may require an auxiliary lamp clip that snaps over standard lamp clip. Please order P-2013-01-00 (one required per lamp)

# Reflector Fabrication Sheet

YOUR REFLECTOR DESIGN CAN BE INCORPORATED INTO ANY BELFER COMPACT FLUORESCENT OR LINEAR FLUORESCENT FIXTURE. SYMMETRICAL OR ASYMMETRICAL, STRAIGHT OR SAW TOOTHED, WHITE OR CHROME... THE POSSIBILITIES ARE LIMITLESS. CHOOSE FROM A STANDARD REFLECTOR DESIGN BELOW OR DRAW YOUR OWN TO DISCUSS THE POSSIBILITIES. ALL REFLECTORS ARE AVAILABLE IN 4' LENGTHS AND ARE FIELD TRIMMABLE.

**SELECT FIXTURE NUMBER:**

- 2801 COMPACT FLUORESCENT
- 2850 COMPACT FLUORESCENT
- 2855 COMPACT FLUORESCENT
- 2880 COMPACT FLUORESCENT

**SELECT REFLECTOR DESIGN:**

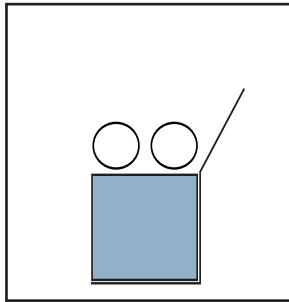

REFLECTOR A

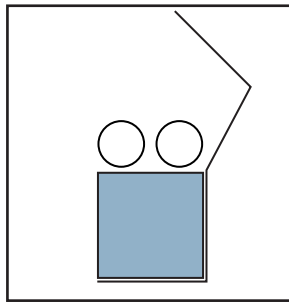

REFLECTOR B

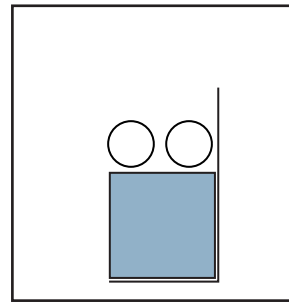

REFLECTOR C

- CUSTOM REFLECTOR    Job Plans or Drawings are Required

